





Square Selector Switch Operators Series BS22



Maintained Operator

Knob Type Options	Square Polyamide
	BSK1-* \$16.00 List
	BSK3-* \$16.00 List
	BSK7-* \$25.00 List

Illuminated Selector Switches (Square Design)



2 Position
BSL-2▲
\$30.00 List





3 Position
BSL-3▲
\$32.00 List

▲ Add Illuminated Knob Color

-R	Red	-W	White
-G	Green	-B	Blue
-Y	Yellow		
-C	Transparent		



Spring Return Operator

	BSK8-* \$33.00 List
	BSK2-* \$21.00 List
	BSK6-* \$21.00 List
	BSK5-* \$21.00 List

Key Operated Selector Switches (Square Design)

Selector Switch with Key 2 Position Maintained



BSS-OK
\$55.00 List

BSS-OA
\$55.00 List

BSS-OE
\$55.00 List

Key Operated Selector Switch

▲ Add Color

-S	Black	-Y	Yellow
-R	Red	-B	Blue
-G	Green		

Selector Switch with Key 3 Position Maintained



BSS-OM
\$62.00 List

Key Operated Selector Switch



3 Position

BSS-OS
\$71.00 List

BSS-4R
\$71.00 List

BSS-2S
\$71.00 List

Selector Switch with Key 4 Position Maintained

















BSS-1V
\$78.00 List

Key Operated Spring Return



BSS-OT
\$71.00 List

● **Key Removable Position.** All keys code 95. Special keys available at extra cost.

Position	Contact Block	Contact Closed	Contact Block
	SES 10		
	SES 10		
	SES 01		
	SES 10		
	SES 10		

SELECTOR SWITCHES KEY SWITCHES
MANY other versions and contact cam selections are available. Request fax options from EEControls.

DIMENSIONS-All Round or Square Operators

Spacing Panels 1-6mm thick (0.24") B22

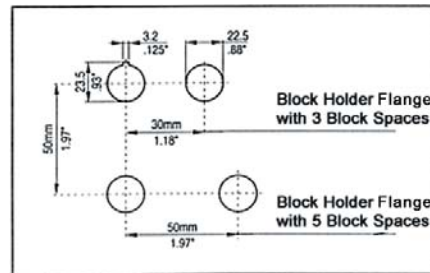

NOTE: This spacing complies with international standard CENELEC EN 50007.

Contact Block Dimensions

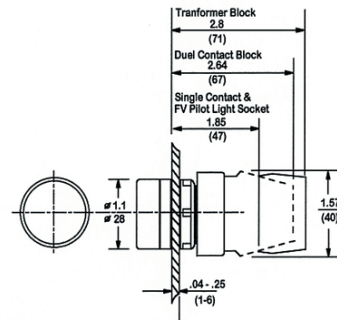

Contact Block Holder

contact block position



30mm (1.2")

contact block position

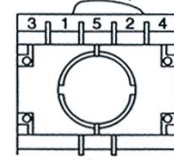

50mm (2")

Contact Block Holder with 3 spaces. This standard holder is supplied with all operators at no charge. **Six poles max. 4 poles max with Lamp Socket.**

BTF C3 \$3.50

If additional Contact Block spaces are required, the 5 space block is required. **Pushbuttons 10 poles max. Illuminated Pushbuttons 8 poles max.**

BTF C5 \$5.00

Mounting Data

Front Mount

