

# **SERIES D DISCONNECT SWITCHES UL508**

**16 Amp - 250 Amp  
600Volt**

**Load Make/Load Break  
Positive Opening  
Compact Size  
Modular Construction  
Horse Power Rated  
Custom Versions**

## **Featuring:**

- Auto Alignment Shaft
- Wide Handle Selection
  - Add-on Auxiliary
  - Add-on Power Poles
  - Add-on Neutral Bar
  - Add-on Neutral Pole
- Under Voltage Trip Option

**OTHER AVAILABLE ET PRODUCTS:  
CAM SWITCHES 25-1200 AMP**



## ***SERIES D DISCONNECTS*** **Machine Safety Disconnect Option**

***FEATURING***  
**HANDLE-SHAFT  
SELF-ALIGNING SYSTEM**

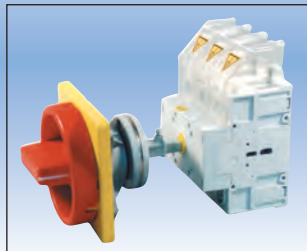



**ELECTRICAL & ELECTRONIC  
CONTROLS, INC.  
3881 DANBURY ROAD  
BREWSTER, NY 10509  
845-278-5777 FAX 845-278-5444  
E-MAIL: [info@eecontrols.com](mailto:info@eecontrols.com)  
[www.eecontrols.com](http://www.eecontrols.com)**



## BASE MOUNT WITH SAFETY DOOR INTERLOCK

8" Adjustable  
mounting depth  
as standard

### 3 POLE

							
		IP 65 Type 4 Rated 1 Padlock		IP 65 Type 4 Rated 3 Padlocks		Bypassable, IP 67 (4X) Rated 2 Padlocks, 22mm Mtg. Hole	
		WITH <b>BE</b> OPERATOR		WITH <b>D</b> OPERATOR		WITH <b>BY</b> OPERATOR	
UNIT SIZE	UL/CSA GENERAL PURPOSE (INDUCTIVE) AMPS	CATALOG NUMBER	LIST PRICE	CATALOG NUMBER	LIST PRICE	CATALOG NUMBER	LIST PRICE
<b>D05</b>	16	<b>E D05-3BE 1 SD-*</b>	\$105	<b>E D05-3D 3 SD-*</b>	\$112	<b>E D05-3BY 1 SD-*</b>	\$172
<b>D1</b>	25	<b>E D1-3BE 1 SD-*</b>	115	<b>E D1-3D 3 SD-*</b>	122	<b>E D1-3BY 1 SD-*</b>	182
<b>D2</b>	40	<b>E D2-3BE 3 SD-*</b>	140	<b>E D2-3D 3 SD-*</b>	147	<b>E D2-3BY 3 SD-*</b>	207
<b>D3</b>	63	<b>E D3-3BE 3 SD-*</b>	155	<b>E D3-3D 3 SD-*</b>	162	<b>E D3-3BY 3 SD-*</b>	222
<b>DK4</b>	80	<b>E DK4-3BE 4 SD-*</b>	250	<b>E DK4-3D 4 SD-*</b>	260	<b>E DK4-3BY 4 SD-*</b>	335
<b>D4</b>	100	<b>E D4-3BE 4 SD-*</b>	270	<b>E D4-3D 4 SD-*</b>	280	<b>E D4-3BY 4 SD-*</b>	355
<b>D5</b>	125	<b>E D5-3BE 4 SD-*</b>	300	<b>E D5-3D 4 SD-*</b>	310	<b>E D5-3BY 4 SD-*</b>	385
<b>D6</b>	200	—————		<b>E D6-3D 5 SD-*</b>	695	—————	
<b>D7</b>	250	—————		<b>E D7-3D 5 SD-*</b>	965	—————	

### 4 POLE

<b>D05</b>	16	<b>E D05-4BE 1 SD-*</b>	\$118	<b>E D05-4D 3 SD-*</b>	\$125	<b>E D05-4BY 1 SD-*</b>	\$185
<b>D1</b>	25	<b>E D1-4BE 1 SD-*</b>	128	<b>E D1-4D 3 SD-*</b>	135	<b>E D1-4BY 1 SD-*</b>	195
<b>D2</b>	40	<b>E D2-4BE 3 SD-*</b>	160	<b>E D2-4D 3 SD-*</b>	167	<b>E D2-4BY 3 SD-*</b>	227
<b>D3</b>	63	<b>E D3-4BE 3 SD-*</b>	175	<b>E D3-4D 3 SD-*</b>	182	<b>E D3-4BY 3 SD-*</b>	242
<b>DK4</b>	80	<b>E DK4-4BE 4 SD-*</b>	285	<b>E DK4-4D 4 SD-*</b>	295	<b>E DK4-4BY 4 SD-*</b>	370
<b>D4</b>	100	<b>E D4-4BE 4 SD-*</b>	305	<b>E D4-4D 4 SD-*</b>	315	<b>E D4-4BY 4 SD-*</b>	390
<b>D5</b>	125	<b>E D5-4BE 4 SD-*</b>	335	<b>E D5-4D 4 SD-*</b>	345	<b>E D5-4BY 4 SD-*</b>	420
<b>D6</b>	200	—————		<b>E D6-4D 5 SD-*</b>	860	—————	
<b>D7</b>	250	—————		<b>E D7-4D 5 SD-*</b>	1130	—————	

**8" DEPTH DIMENSION** is standard on units sized 16-250Amp with through the door safety interlock mechanism.

\* **SUFFIX:** Add -RG for Red-Yellow operator handle.  
 Add -SS for Black handle "D" & "BY" type only.  
 Add -SI for Black-Silver operator "BE" handle.

**6 Pole** Versions available. Contact Factory.

SHAFT EXTENSIONS			
Switch Size	Shaft Length *	Catalog Number	List Price
D05 - D3	200mm (7.87 in)	ED-SE-5	\$21
DK4 - D5	155mm (6.10 in)	ED-SE-7	22
D6, D7	134mm (5.27 in)	ED-SE-11	27



\* Field cut the shaft to length

### Base Mount (Mounts Inside Enclosure)

### Front Mount (External Operator)

## 3 POLE

		1 Padlock		3 Padlocks		1 Padlock		3 Padlocks	
		IP 65 Type 4 Rated							
Unit Size	AMPS	WITH BE OPERATOR		WITH D OPERATOR		WITH BE OPERATOR		WITH D OPERATOR	
		CATALOG NUMBER	LIST PRICE	CATALOG NUMBER	LIST PRICE	CATALOG NUMBER	LIST PRICE	CATALOG NUMBER	LIST PRICE
D05	16	E D05-3BE 1 BM-*	\$75	E D05-3D 3 BM-*	\$82	E D05-3BE 1 FM-*	\$65	E D05-3D 3 FM-*	\$72
D1	25	E D1-3BE 1 BM-*	80	E D1-3D 3 BM-*	87	E D1-3BE 1 FM-*	70	E D1-3D 3 FM-*	77
D2	40	E D2-3BE 3 BM-*	123	E D2-3D 3 BM-*	130	E D2-3BE 3 FM-*	108	E D2-3D 3 FM-*	115
D3	63	E D3-3BE 3 BM-*	147	E D3-3D 3 BM-*	154	E D3-3BE 3 FM-*	132	E D3-3D 3 FM-*	139
DK4	80	E DK4-3BE 4 BM-*	190	E DK4-3D 4 BM-*	200	E DK4-3BE 4 FM-*	170	E DK4-3D 4 FM-*	180
D4	100	E D4-3BE 4 BM-*	218	E D4-3D 4 BM-*	228	E D4-3BE 4 FM-*	198	E D4-3D 4 FM-*	208
D5	125	E D5-3BE 4 BM-*	260	E D5-3D 4 BM-*	270	E D5-3BE 4 FM-*	240	E D5-3D 4 FM-*	250
D6	200	————		E D6-3D 5 BM-*	650	————		E D6-3D 5 FM-*	620
D7	250	————		E D7-3D 5 BM-*	905	————		E D7-3D 5 FM-*	875

## 4 POLE

D05	16	E D05-4BE 1 BM-*	\$88	E D05-4D 3 BM-*	\$95	E D05-4BE 1 FM-*	\$78	E D05-4D 3 FM-*	\$85
D1	25	E D1-4BE 1 BM-*	93	E D1-4D 3 BM-*	100	E D1-4BE 1 FM-*	83	E D1-4D 3 FM-*	90
D2	40	E D2-4BE 3 BM-*	143	E D2-4D 3 BM-*	150	E D2-4BE 3 FM-*	128	E D2-4D 3 FM-*	135
D3	63	E D3-4BE 3 BM-*	167	E D3-4D 3 BM-*	174	E D3-4BE 3 FM-*	152	E D3-4D 3 FM-*	159
DK4	80	E DK4-4BE 4 BM-*	225	E DK4-4D 4 BM-*	235	E DK4-4BE 4 FM-*	205	E DK4-4D 4 FM-*	215
D4	100	E D4-4BE 4 BM-*	253	E D4-4D 4 BM-*	263	E D4-4BE 4 FM-*	233	E D4-4D 4 FM-*	243
D5	125	E D5-4BE 4 BM-*	295	E D5-4D 4 BM-*	305	E D5-4BE 4 FM-*	275	E D5-4D 4 FM-*	285
D6	200	————		E D6-4D 5 BM-*	815	————		E D6-4D 5 FM-*	785
D7	250	————		E D7-4D 5 BM-*	1070	————		E D7-4D 5 FM-*	1040

\* SUFFIX: Add -RG for Red-Yellow operator handle.  
Add -SS for Black handle "D" type only.  
Add -SI for Black-Silver operator "BE" handle.

2 Pole (Size D1 Only)

Deduct \$10 from List Price

P/N Example:

Change 3 to 2: E D1-3BE (3 Pole)

E D1-2BE (2 Pole)

### E D2-3D 3 BM-RG

Frame Size	2	3	3	D	RG
# of Poles	2	3	3	D	RG
Handle Type				D	RG

Handle Color
Mounting Style
Face Plate Size

## SINGLE HOLE MOUNT

### 3 POLE

UNIT SIZE	UL/CSA GENERAL PURPOSE (INDUCTIVE) AMPS	WITH BE OPERATOR		WITH D OPERATOR	
		CATALOG NUMBER	LIST PRICE	CATALOG NUMBER	LIST PRICE
D05	16	E D05-3BE 1 SH-*	\$98	E D05-3D 2 SH-*	\$105
D1	25	E D1-3BE 1 SH-*	103	E D1-3D 2 SH-*	110
D2	40	E D2-3BE 2 SH-*	163	E D2-3D 2 SH-*	170
D3	63	E D3-3BE 2 SH-*	183	E D3-3D 2 SH-*	190

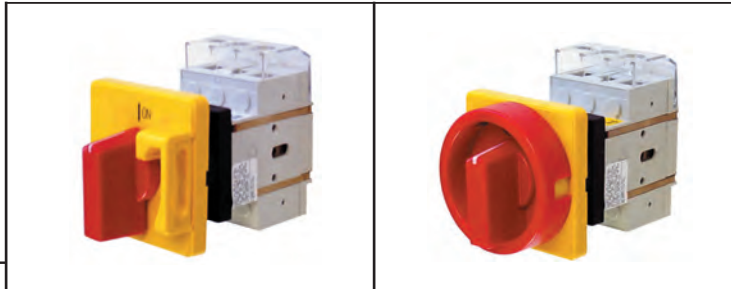

### 4 POLE

D05	16	E D05-4BE 1 SH-*	\$111	E D05-4D 2 SH-*	\$118
D1	25	E D1-4BE 1 SH-*	116	E D1-4D 2 SH-*	123
D2	40	E D2-4BE 2 SH-*	183	E D2-4D 2 SH-*	190
D3	63	E D3-4BE 2 SH-*	203	E D3-4D 2 SH-*	210

**\*SUFFIX:** Add -RG for Red-Yellow operator handle.  
Add -SS for Black handle "D" type only.  
Add -SI for Black-Silver operator "BE" handle.

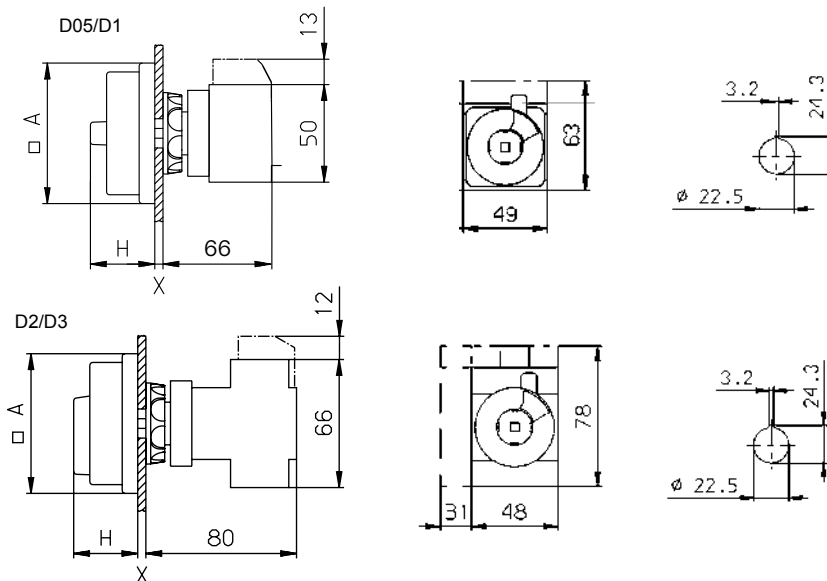





Handle Type Size	BE		D		X <sub>max.</sub>
	A	H	A	H	
D05/D1	48	27	72	34	4
D2 / D3	72	34	72	34	4

Size	PE, N B1	1-AUX B1	2-AUX B1
D05/D1	-	-	-
D2 / D3	17	11	19

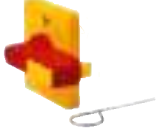

## Replacement Operator Handles

<b>BE Type</b> Front Mount, Base Mount Operators		<b>D Type</b> Front Mount, Base Mount Operators		<b>BE Type</b> Safety Door Provision		<b>D Type</b> Safety Door Provision		<b>BY Type</b> Safety Door Provision		
										
no interlock provisions		no interlock provisions		interlock provisions		interlock provisions		interlock provisions		
SIZE	PART#	LIST	PART#	LIST	PART#	LIST	PART#	LIST	PART#	LIST
ED05-ED1	E BE-**-S05	\$25	E D-**-S1	\$26	E BE-SD-**-S05	\$44	E D-SD-**-S1	\$45	BY-1-**-S1	\$81
ED2-ED3	E BE-**-S1	\$26	E D-**-S1	\$26	E BE-SD-**-S1	\$45	E D-SD-**-S1	\$45	BY-1-**-S1	\$81
EDK4-ED5	E BE-**-S2	\$32	E D-**-S2	\$32	E BE-SD-**-S2	\$58	E D-SD-**-S2	\$58	BY-1-**-S2	\$90
ED6-ED7			E D-**-S3	\$41			E D-SD-**-S3	\$76		

**\*\* Replace Asterix with handle color suffix:**  
 “RG” for red/yellow operator handle  
 “SS” for black handle (D & BY type only)  
 “SI” for black silver operator (BE type)

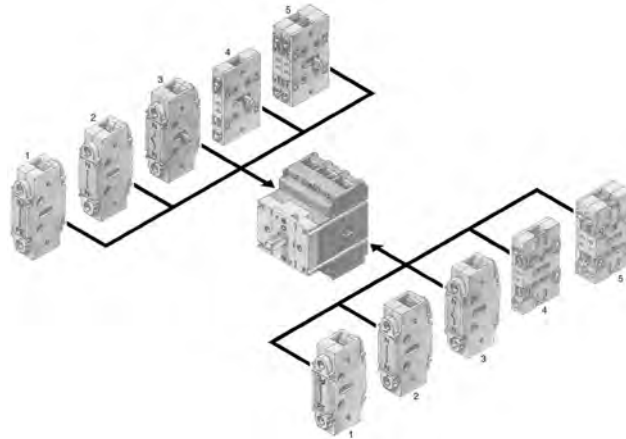

## One per side mounting

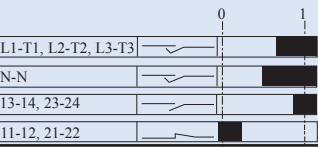

Front mount: terminal screws accessible from the rear

Rear mount: terminal screws accessible from the front

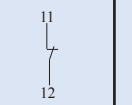
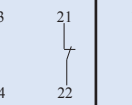
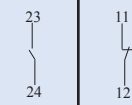
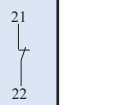
Element		1	2	3
Functional Diagram		Ground PE terminal	N terminal	Additional Power Pole
		PE	N	N N Neutral Switch
Size				
D2/D3	Front mounting FM, SH	ED-NPE23 \$13	ED-NPE21 \$13	ED-NPE25 \$20
	Rear mounting SD, BM	ED-NPE24 \$13	ED-NPE22 \$13	ED-NPE26 \$20
DK4/D4/D5	Front mounting FM, SH	ED-NPE33 \$21	ED-NPE31 \$21	ED-NPE35 \$35
	Rear mounting SD, BM	ED-NPE34 \$21	ED-NPE32 \$21	ED-NPE36 \$35
D6/D7	Front mounting FM, SH	ED-NPE434 \$56	ED-NPE412 \$56	ED-NPE45 \$165
	Rear mounting SD, BM	ED-NPE434 \$56	ED-NPE412 \$56	ED-NPE46 \$165

4		5			
Auxiliary Switch 12 Amp		Auxiliary Switch 12A Ith			
1NO	1NC	1NO + 1NC	2NO	2 NC	
					
ED-HF10 \$24	ED-HF01 \$24	ED-HF11 \$32	ED-HF20 \$32	ED-HF02 \$32	
ED-HC10 \$24	ED-HC01 \$24	ED-HC11 \$32	ED-HC20 \$32	ED-HC02 \$32	
ED-HF10 \$24	ED-HF01 \$24	ED-HF11 \$32	ED-HF20 \$32	ED-HF02 \$32	
ED-HC10 \$24	ED-HC01 \$24	ED-HC11 \$32	ED-HC20 \$32	ED-HC02 \$32	
ED-HF10 \$24	ED-HF01 \$24	ED-HF11 \$32	ED-HF20 \$32	ED-HF02 \$32	
ED-HC10 \$24	ED-HC01 \$24	ED-HC11 \$32	ED-HC20 \$32	ED-HC02 \$32	

## 3 POLE

				IP 55 Non-Metal					
Unit Size	AMPS	Type 4/12 Enclosure		Type 4X Enclosure		Type 4/12 Enclosure		Type 4X Enclosure	
		CATALOG NUMBER	LIST PRICE	CATALOG NUMBER	LIST PRICE	CATALOG NUMBER	LIST PRICE	CATALOG NUMBER	LIST PRICE
D05	16	E D05-3BE-M1-*	\$135	E D05-3D-S4-*	\$178	E D05-3D-M12-*	\$200	E D05-3BY-4X-*	\$220
D1	25	E D1-3BE-M1-*	145	E D1-3D-S4-*	188	E D1-3D-M12-*	210	E D1-3BY-4X-*	230
D2	40	E D2-3BE-M1-*	205	E D2-3D-S4-*	264	E D2-3D-M12-*	275	E D2-3BY-4X-*	290
D3	63	E D3-3BE-M1-*	255	E D3-3D-S4-*	279	E D3-3D-M12-*	295	E D3-3BY-4X-*	340
DK4	80	E DK4-3BE-M1-*	320			E DK4-3D-M12-*	350	E DK4-3BY-4X-*	430
D4	100	E D4-3BE-M1-*	392			E D4-3D-M12-*	425	E D4-3BY-4X-*	488
D5	125	E D5-3BE-M1-*	466			E D5-3D-M12-*	486	E D5-3BY-4X-*	534
D6	200	E D6-3D-M1-*	925			E D6-3D-M12-*	990		
D7	250	E D7-3D-M1-*	1235			E D7-3D-M12-*	1400		

## 4 POLE

D05	16	E D05-4BE-M1-*	\$148	E D05-4D-S4-*	\$191	E D05-4D-M12-*	\$213	E D05-4BY-4X-*	\$233
D1	25	E D1-4BE-M1-*	158	E D1-4D-S4-*	201	E D1-4D-M12-*	223	E D1-4BY-4X-*	243
D2	40	E D2-4BE-M1-*	225	E D2-4D-S4-*	284	E D2-4D-M12-*	295	E D2-4BY-4X-*	310
D3	63	E D3-4BE-M1-*	275	E D3-4D-S4-*	299	E D3-4D-M12-*	315	E D3-4BY-4X-*	360
DK4	80	E DK4-4BE-M1-*	355			E DK4-4D-M12-*	385	E DK4-4BY-4X-*	465
D4	100	E D4-4BE-M1-*	427			E D4-4D-M12-*	460	E D4-4BY-4X-*	523
D5	125	E D5-4BE-M1-*	500			E D5-4D-M12-*	521	E D5-4BY-4X-*	569
D6	200	E D6-4D-M1-*	1090			E D6-4D-M12-*	1155		
D7	250	E D7-4D-M1-*	1400			E D7-4D-M12-*	1565		

\* SUFFIX: Add -RG for Red-Yellow operator handle.  
 Add -SS for Black handle "D" & "BY" type only.  
 Add -SI for Black-Silver operator "BE" handle.

### E D2-3D-M12-RG

Frame Size \_\_\_\_\_  
 # of Poles \_\_\_\_\_  
 Handle Type \_\_\_\_\_

Handle Color \_\_\_\_\_  
 Enclosure Type \_\_\_\_\_