

R-Series Pushbuttons, Selector Switches

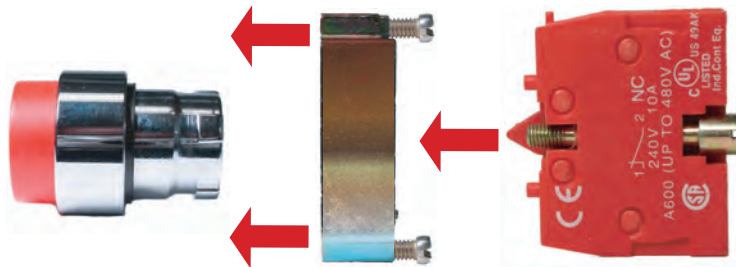

LED Pilot Light's Modular 22mm + 30mm



Metal
Chrome
Bezel

Steel Block Holder
Included with operators

Bolt - On
Contact
Block

A Secure + Safe System Versus Snap on Contacts



Pushbuttons

22 mm, UL Type 4



IEC 947-1

-13°, + 158°F Ambient Temp

Pushbuttons and Selectors
1 million mechanical Oper.
Emergency Stop
300,000 Operations

1th10 Amp, 600Volt
A600, Q600

FEATURES

- High Gloss Chrome
 - Rugged Design
 - Very Bright LED's (22 & 30mm)
 - Modular Design
 - Secure Screw Mounting
 - Self Cleaning Contacts
 - Stackable Contacts
 - Positive Open Contacts (→)
- Per IEC - 947-5-1

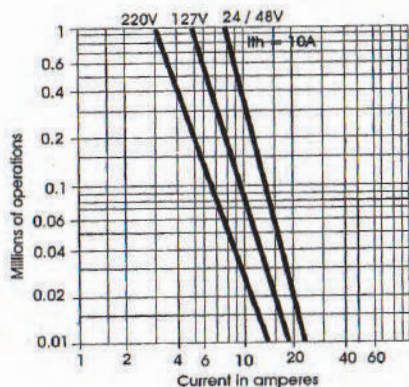

AC Ratings, A600

Inductive 35% Power Factor

Volts	Make Amperes	VA	Break Amperes	VA	Continuous carrying Amperes	Resistive 75% Power factor Make, Break & continuous Amperes
120	60	7200	6	720	10	10
240	30	7200	3	720	10	10
480	15	7200	1.5	720	10	10
600	12	7200	1.2	720	10	10

DC Ratings, Q600

Inductive and Resistive Amps

Volts	Make & Break (Amp.)	Continuous (Amp.)
125	0.55	2.5
250	0.27	2.5
600	0.10	2.5

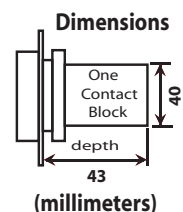

Minimum AC/DC 17 Volts, 25mA



Momentary Flush Pushbutton





Color	Operator Only
Green	R-G
Red	R-R
Black	R-B
Yellow	R-Y
Blue	R-BL
White	R-W
Arrow	R-AR
List \$	\$5.00

Single Contact			Double Contacts		
					
Part #	1 Open Contact -* 10	1 Closed Contact -* 01	2 Open Contacts -* 20	2 Closed Contacts -* 02	1 Closed, 1 Open Contacts -* 11
	List	List	List	List	List
R-G-*	\$11.00	\$11.00	\$17.00	\$17.00	\$17.00
R-R-*	\$11.00	\$11.00	\$17.00	\$17.00	\$17.00
R-B-*	\$11.00	\$11.00	\$17.00	\$17.00	\$17.00
R-Y-*	\$11.00	\$11.00	\$17.00	\$17.00	\$17.00
R-BL-*	\$11.00	\$11.00	\$17.00	\$17.00	\$17.00
R-W-*	\$11.00	\$11.00	\$17.00	\$17.00	\$17.00
R-AR-*	\$11.00	\$11.00	\$17.00	\$17.00	\$17.00

Momentary Extended Pushbutton





Color	Operator Only
Green	R-G-E
Red	R-R-E
Black	R-B-E
Yellow	R-Y-E
Blue	R-BL-E
White	R-W-E
Arrow	R-AR-E
List \$	\$5.00

Single Contact			Double Contacts		
					
Part #	1 Open Contact -* 10	1 Closed Contact -* 01	2 Open Contacts -* 20	2 Closed Contacts -* 02	1 Closed, 1 Open Contacts -* 11
	List	List	List	List	List
R-G-E-*	\$11.00	\$11.00	\$17.00	\$17.00	\$17.00
R-R-E-*	\$11.00	\$11.00	\$17.00	\$17.00	\$17.00
R-B-E-*	\$11.00	\$11.00	\$17.00	\$17.00	\$17.00
R-Y-E-*	\$11.00	\$11.00	\$17.00	\$17.00	\$17.00
R-BL-E-*	\$11.00	\$11.00	\$17.00	\$17.00	\$17.00
R-W-E-*	\$11.00	\$11.00	\$17.00	\$17.00	\$17.00
R-AR-E-*	\$11.00	\$11.00	\$17.00	\$17.00	\$17.00

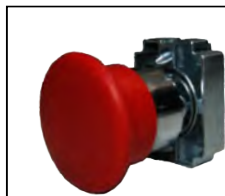
40mm Momentary Mushroom Pushbutton



Color	Operator Only
Green	R-G-M
Red	R-R-M
Black	R-B-M
Yellow	R-Y-M
Blue	R-BL-M
White	R-W-M
List \$	\$7.00

Single Contact			Double Contacts		
					
Part #	1 Open Contact -* 10	1 Closed Contact -* 01	2 Open Contacts -* 20	2 Closed Contacts -* 02	1 Closed, 1 Open Contacts -* 11
	List	List	List	List	List
R-G-M-*	\$13.00	\$13.00	\$19.00	\$19.00	\$19.00
R-R-M-*	\$13.00	\$13.00	\$19.00	\$19.00	\$19.00
R-B-M-*	\$13.00	\$13.00	\$19.00	\$19.00	\$19.00
R-Y-M-*	\$13.00	\$13.00	\$19.00	\$19.00	\$19.00
R-BL-M-*	\$13.00	\$13.00	\$19.00	\$19.00	\$19.00
R-W-M-*	\$13.00	\$13.00	\$19.00	\$19.00	\$19.00

Selector Switch (Short Lever)



Number of Positions	Description	Operator Only
2	Maintained	R-2M
	Spring Return (R to L)	R-2R
3	Maintained	R-3M
	Spring Return to Center	R-3R
	Spring Return (L to C)	R-3LEFT
	Spring Return (R to C)	R-3RIGHT
List \$		\$11.00

Single Contact	Double Contacts
----------------	-----------------



Part #	1 Open Contact -* 10	2 Open Contacts -* 20
	List	List
R-2M-*	\$17.00	\$23.00
R-2R-*	\$17.00	\$23.00
R-3M-*		\$23.00
R-3R-*		\$23.00
R-3LEFT-*		\$23.00
R-3RIGHT-*		\$23.00

Selector Switch (Long Lever)



Number of Positions	Description	Operator Only
2	Maintained	RL-2M
	Spring Return (R to L)	RL-2R
3	Maintained	RL-3M
	Spring Return to Center	RL-3R
	Spring Return (L to C)	RL-3LEFT
	Spring Return (R to C)	RL-3RIGHT
List \$		\$11.00

Single Contact	Double Contacts
----------------	-----------------

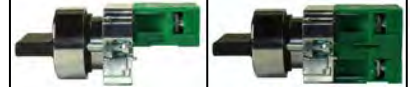

Part #	1 Open Contact -* 10	2 Open Contacts -* 20
	List	List
RL-2M-*	\$17.00	\$23.00
RL-2R-*	\$17.00	\$23.00
RL-3M-*		\$23.00
RL-3R-*		\$23.00
RL-3LEFT-*		\$23.00
RL-3RIGHT-*		\$23.00

Keyed Selector Switch



Number of Positions	Description	Key Removal	Operator Only
2	Maintained	Both	R-2KEY
	Maintained	Left	R-2KEYL
	Maintained	Right	R-2KEYR
	Spring Return (R to L)	Left	R-KEYC
3	Maintained	All	R-3KEY-AP
	Maintained	Center	R-3KEYC
	Maintained	L + R	R-3KEY-RL
	Maintained	Left	R-3KEY-L
	Maintained	Right	R-3KEY-R
	Spring Return to Center	Center	R-3KEY-CSTOC
	Spring Return (R to C)	Center	R-3KEY-CSTRT
List \$		\$15.00	

Single Contact	Double Contacts
----------------	-----------------





Part #	1 Open Contact -* 10	2 Open Contacts -* 20
	List	List
R-2KEY-*	\$21.00	\$27.00
R-2KEYL-*	\$21.00	\$27.00
R-2KEYR-*	\$21.00	\$27.00
R-KEYC-*	\$21.00	\$27.00
R-3KEY-AP-*		\$27.00
R-3KEYC-*		\$27.00
R-3KEY-RL-*		\$27.00
R-3KEY-L-*		\$27.00
R-3KEY-R-*		\$27.00
R-3KEY-CSTOC-*		\$27.00
R-3KEY-CSTRT-*		\$27.00

Illuminated Flush Pushbutton



Color	Operator Only
Green	R-GL
Red	R-RL
Yellow	R-YL
Blue	R-BLL
List \$	\$6.00

		Single Contact		Double Contacts		
						
Part #	1 Open Contact -* 10	1 Closed Contact -* 01	2 Open Contacts -* 20	2 Closed Contacts -* 02	1 Closed, 1 Open Contacts -* 11	
	List	List	List	List	List	
R-GL-*^A	\$25.00	\$25.00	\$31.00	\$31.00	\$31.00	
R-RL-*^A	\$25.00	\$25.00	\$31.00	\$31.00	\$31.00	
R-YL-*^A	\$25.00	\$25.00	\$31.00	\$31.00	\$31.00	
R-BLL-*^A	\$41.00	\$41.00	\$47.00	\$47.00	\$47.00	



Example:
R-GL-10-A
Green ill. PB w/ 1N.O. contact & 110V bulb.

LED Bulb Voltage	
- ^	Voltage
M	12 V AC/DC
G	24 V AC/DC
O	48 V AC/DC
A	110 V AC/DC

Illuminated Extended Pushbutton



Color	Operator Only
Green	R-GLE
Red	R-RLE
Yellow	R-YLE
Blue	R-BLLE
List \$	\$6.00

		Single Contact		Double Contacts		
						
Part #	1 Open Contact -* 10	1 Closed Contact -* 01	2 Open Contacts -* 20	2 Closed Contacts -* 02	1 Closed, 1 Open Contacts -* 11	
	List	List	List	List	List	
R-GLE-*^A	\$25.00	\$25.00	\$31.00	\$31.00	\$31.00	
R-RLE-*^A	\$25.00	\$25.00	\$31.00	\$31.00	\$31.00	
R-YLE-*^A	\$25.00	\$25.00	\$31.00	\$31.00	\$31.00	
R-BLLE-*^A	\$41.00	\$41.00	\$47.00	\$47.00	\$47.00	

Example:
R-RLE-10-A
Red ill. PB w/ 1N.O. contact & 110V bulb.



LED Bulb Voltage	
- ^	Voltage
M	12 V AC/DC
G	24 V AC/DC
O	48 V AC/DC
A	110 V AC/DC

Illuminated Mushroom Pushbutton



Momentary
Maintained Push/Pull

Color	Operator Only
Green	R-GL-MO
Red	R-RL-MO
List \$	\$15.00
Green	R-GL-MA
Red	R-ESTOP-L
List \$	\$17.00

		Single Contact		Double Contacts		
						
Part #	1 Open Contact -* 10	1 Closed Contact -* 01	2 Open Contacts -* 20	2 Closed Contacts -* 02	1 Closed, 1 Open Contacts -* 11	
	List	List	List	List	List	
R-GL-MO-*^A	\$34.00	\$34.00	\$40.00	\$40.00	\$40.00	
R-RL-MO-*^A	\$34.00	\$34.00	\$40.00	\$40.00	\$40.00	
R-GL-MA-*^A	\$36.00	\$36.00	\$42.00	\$42.00	\$42.00	
R-ESTOP-L-*^A	\$36.00	\$36.00	\$42.00	\$42.00	\$42.00	

Example:
R-GL-MO-10-A
Green ill. Mushroom w/ 1N.O. contact & 110V bulb.



LED Bulb Voltage	
- ^	Voltage
M	12 V AC/DC
G	24 V AC/DC
O	48 V AC/DC
A	110 V AC/DC

Illuminated Selector Switch



2 Position
3 Position

Color	Operator Only
Green	R-GL-2
Red	R-RL-2
Yellow	R-YL-2
Green	R-GL-3
Red	R-RL-3
Yellow	R-YL-3
List \$	\$15.00

		Single Contact		Double Contacts		
						
Part #	1 Open Contact -* 10	1 Closed Contact -* 01	2 Open Contacts -* 20	2 Closed Contacts -* 02	1 Closed, 1 Open Contacts -* 11	
	List	List	List	List	List	
R-GL-2-*^A	\$34.00	\$34.00	\$40.00	\$40.00	\$40.00	
R-RL-2-*^A	\$34.00	\$34.00	\$40.00	\$40.00	\$40.00	
R-YL-2-*^A	\$34.00	\$34.00	\$40.00	\$40.00	\$40.00	
R-GL-3-*^A	—	—	\$40.00	\$40.00	\$40.00	
R-RL-3-*^A	—	—	\$40.00	\$40.00	\$40.00	
R-YL-3-*^A	—	—	\$40.00	\$40.00	\$40.00	



Example:
R-RL-2-10-A
Red ill. Selector w/ 1N.O. contact & 110V bulb.

LED Bulb Voltage	
- ^	Voltage
M	12 V AC/DC
G	24 V AC/DC
O	48 V AC/DC
A	110 V AC/DC

Emergency Stopbutton & Stations



E-Stop Mushroom Push Pull

	Color	Operator Only
	Red	R-R-PP
	List \$	\$17.00

	Single Contact		Double Contacts		
					
Part #	1 Open Contact -* 10	1 Closed Contact -* 01	2 Open Contact -* 20	2 Closed Contact -* 02	1 Closed, 1 Open Contacts -* 11
R-R-PP-*	\$23.00	\$23.00	\$29.00	\$29.00	\$29.00



40 mm E-Stop Twist to Release

	Color	Operator Only
	Red	R-ESTOP
	List \$	\$17.00

	Single Contact		Double Contacts		
					
Part #	1 Open Contact -* 10	1 Closed Contact -* 01	2 Open Contact -* 20	2 Closed Contact -* 02	1 Closed, 1 Open Contacts -* 11
R-ESTOP-*	\$23.00	\$23.00	\$29.00	\$29.00	\$29.00



60 mm E-Stop Twist to Release

	Color	Operator Only
	Red	R-ESTOP-60
	List \$	\$17.00

	Single Contact		Double Contacts		
					
Part #	1 Open Contact -* 10	1 Closed Contact -* 01	2 Open Contact -* 20	2 Closed Contact -* 02	1 Closed, 1 Open Contacts -* 11
R-ESTOP-60-*	\$23.00	\$23.00	\$29.00	\$29.00	\$29.00

E-Stop Mushroom Key to Release

	Color	Operator Only
	Red	R-ESTOP-KEY
	List \$	\$23.00

	Single Contact		Double Contacts		
					
Part #	1 Open Contact -* 10	1 Closed Contact -* 01	2 Open Contact -* 20	2 Closed Contact -* 02	1 Closed, 1 Open Contacts -* 11
R-ESTOP-KEY-*	\$29.00	\$29.00	\$35.00	\$35.00	\$35.00

All above operators come with plastic e-stop legend included.

Enclosed E-Stop Stations Push Pull



Description	Part #	1 Normally Closed Contact -* 01	2 Normally Closed Contacts -* 02	1 Closed & 1 Open Contacts -* 11
Plastic	R-R-PP-*-P	\$41.00	\$47.00	\$47.00
Aluminum	R-R-PP-*-A	\$49.00	\$55.00	\$55.00

Enclosed E-Stop Stations Key to Release



Description	Part #	1 Normally Closed Contact -* 01	2 Normally Closed Contacts -* 02	1 Closed & 1 Open Contacts -* 11
Plastic	R-ESTOPKEY-*-P	\$47.00	\$53.00	\$53.00
Aluminum	R-ESTOPKEY-*-A	\$55.00	\$61.00	\$61.00

Enclosed E-Stop Stations Twist to Release



Description	Part #	1 Normally Closed Contact -* 01	2 Normally Closed Contacts -* 02	1 Closed & 1 Open Contacts -* 11
Plastic	R-ESTOP-*-P	\$41.00	\$47.00	\$47.00
Aluminum	R-ESTOP-*-A	\$49.00	\$55.00	\$55.00

Start Stop Operators & Pilot Lights

Start / Stop



	Operator Only	Assembled 1 N.O. + 1 N.C.
Part #	R-S-ST	R-S-ST-11
List \$	\$5.00	\$17.00



Boot Fits R-S-STPL Only

	Operator Only
Part #	BSC-DT-BOOT
List \$	\$6.00

Start / Stop



	Operator Only	Assembled 1 N.O. + 1 N.C.
Part #	R-S-STPL	R-S-STPL-11-*
List \$	\$5.00	\$24.75

Incandescent Bulb Add Suffix	
- *	Voltage
G	24 V AC/DC
A	110 V AC/DC

c  us EN 60947-5-1 

Pilot Light (LED)



Color	Part #
Green	B22 LED-G- *
Red	B22 LED-R- *
Yellow	B22 LED-Y- *
Blue	B22 LED-B- *
White	B22 LED-W- *
List \$	\$20.00

(* Add Suffix for Voltage

-A	110 VAC
-C	220 VAC
-G	24 VAC / DC
-O	48 VAC / DC
-D	380 VAC
-M	12 VAC / DC

For 30mm LED pilot light simply Add suffix "30" to end of part #





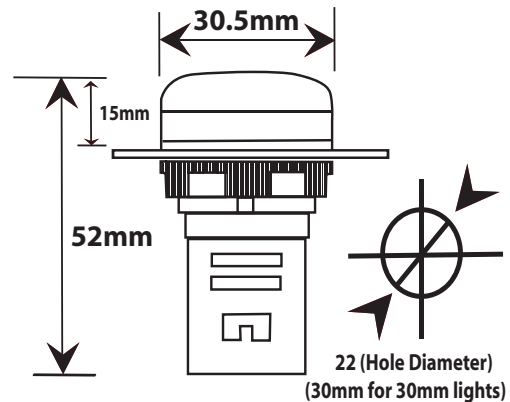



- Operational Temperature - -13^o+ 130^oF
- Protection Degree NEMA 4X - IP65
- Current Draw -Ie MA<80- (6, 12v)
20- , 48), 110, 220V.
- Brightness d/M² ≥ 60
- AC Rated Frequency = -50/60 HZ
- Saddle Clamp Screw Terminals.
- Mounting - 22mm or 30mm hole diameter.



 NEMA 4X Rubber Boot Recommended for washdown Applications	Boot Colors	Part #
	WHITE	R-BOOT
	GREEN	R-GBOOT
	RED	R-RBOOT
	AMBER	R-ABOOT
	BLUE	R-BBOOT
	CLEAR	R-BOOTCL
	List \$	\$ 4.00

Emergency Stop Name Plates		
	Description	Part #
	60mm Plastic	R-60PESTOP
	90mm Plastic	R-90PESTOP
	60mm Aluminum	R-60AESTOP
	90mm Aluminum	R-90AESTOP
	List \$	\$ 4.00

 Block Holder	Spare Steel Block Holder Part # R-BLOCK \$2.00 List
 Incandescent spare bulbs	Part # R-BULB-12V R-BULB-24V \$4.00 List R-BULB-48V R-BULB-130V
 Spade Connection	Quick connect (male) terminal. Part # R-QC \$0.50 List
 Spare Key	Part # R-KEY \$3.00 List
 Padlock Cover	For Flush Pushbuttons ONLY Part # R-COVER \$6.00 List
 30 to 22mm Hole Adaptor	Part # R-30 - 22 \$2.00 List
 Bulb Remover	Part # R-TOOL \$4.00 List

Light Sockets + LED Bulb			
	Description	Part #	List Price
	LED - Green	R-G-LED-*	\$13.00
	LED - Red	R-R-LED-*	\$13.00
	LED - Yellow	R-Y-LED-*	\$13.00
	LED - Blue	R-B-LED-*	\$29.00

AC/DC Voltage	12	24	48	110
Suffix *	-M	-G	-O	-A

Light Socket + Incandescent Bulb			
	Description	Part #	List Price
	BA9 Style Incandescent Bulb w/ Holder	R-T-*	\$7.75

AC/DC Voltage	12	24	48	110	220
Suffix *	-M	-G	-O	-A	-C

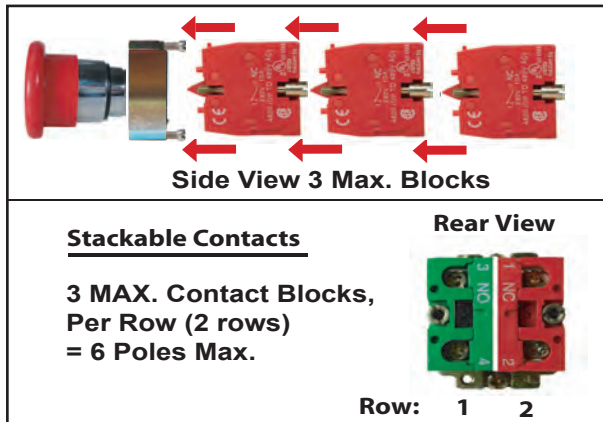

Terminal Marking Numbers	Contact Block	10A	600 A	Part #	List Price
3 - 4	Normally Open			R-NO	\$6.00
13 - 14	Normally Open			R-NO1314	\$6.00
1 - 2	Normally Closed			R-NC	\$6.00
21 - 22	Normally Closed			R-NC2122	\$6.00
1 - 2	N.C. with Gold Flash			R-NC-G	\$15.00
3 - 4	N.O. with Gold Flash			R-NO-G	\$15.00

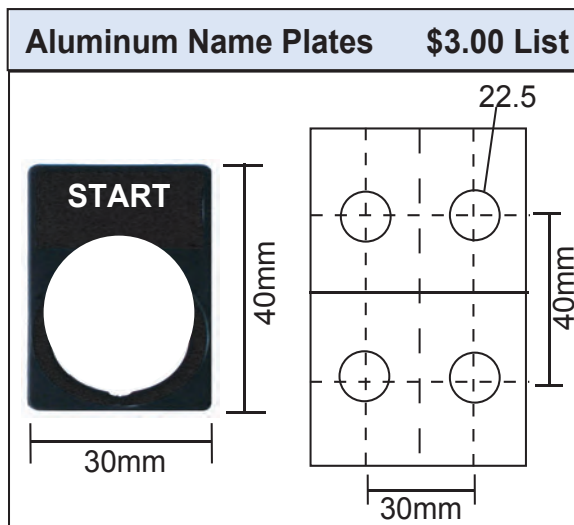

NAME PLATE PART #	
R-OFF	R-STOP START
R-STOP	R-OPEN
R-START	R-RESET
R-FOWARD	R-CLOSE
R-REVERSE	R-HIGH LOW
R-UP	R-AUTO
R-DOWN	R-HAND
R-HAND OFF AUTO	R-FAST
R-EMERGENCY STOP	R-SLOW
R-OFF ON	R-HIGH
R-INCH	R-LOW
R- Blank	R-Run

R-2PPBA



Pushbutton Stations - Type 4/4X

# of Holes	Thermoplastic	List Price
1	R-1PBP	\$18.00
2	R-2PBP	\$19.00
3	R-3PBP	\$22.00
4	R-4PBP	\$31.00
1(yellow)	R-1PBPY	\$18.00

R-1PBPY



R-1PBA



	Aluminum Die Cast	List Price
1	R-1PBA	\$26.00
2	R-2PBA	\$30.00
3	R-3PBA	\$33.00
4	R-4PBA	\$41.00

- Notes:
- Holes are 22mm.
 - Enclosures will not work with illuminated buttons.
 - Only one row of contacts allowed.